

1.A

1.B

1.C

2.A

2.B

2.C

GRADE 1

GRADE 2

no concrete or drawings
2.NBT.7
2.NBT.8
2.NBT.1

2.OA.4
2.OA.3

no two-step and harder
2.OA.1

2.G.2
1.G.2
2.MD.1

2.MD.2
2.G.3

2.MD.6

no memory
2.OA.2

no fluency
2.NBT.5

no two-step, harder types
2.OA.1

no two-step and harder one-step
2.NBT.5
2.OA.1

2.MD.2
2.MD.4

2.MD.3
2.MD.5

2.MD.1
2.MD.4

2.MD.2
2.MD.4

2.MD.3
2.MD.5

2.NBT.4
2.NBT.6

no concrete or drawings
2.NBT.7
2.NBT.7

2.NBT.7
2.NBT.9

2.NBT.8
2.NBT.8

2.NBT.2
2.NBT.3

2.OA.3
2.OA.4

2.G.2
2.G.3

2.G.1
2.G.1

2.MD.7

fluency to 15; no memory
2.OA.2

no fluency
2.NBT.5

no two-step, harder types
2.OA.1

no two-step and harder one-step
2.NBT.5
2.OA.1

2.MD.2
2.MD.4

2.MD.3
2.MD.5

2.MD.1
2.MD.4

2.MD.2
2.MD.4

2.MD.3
2.MD.5

2.NBT.4
2.NBT.6

no concrete or drawings
2.NBT.7
2.NBT.7

2.NBT.7
2.NBT.9

2.NBT.8
2.NBT.8

2.NBT.2
2.NBT.3

2.OA.3
2.OA.4

2.G.2
2.G.3

2.G.1
2.G.1

2.MD.7

no concrete or drawings
1.OA.1

1.OA.2
1.OA.2

1.OA.8
1.OA.8

1.OA.7
1.OA.7

1.MD.4
1.MD.4

1.NBT.4
1.NBT.4

no concrete or drawings
1.NBT.4

1.OA.1
1.OA.1

1.OA.6
1.OA.6

1.NBT.4
1.NBT.4

1.NBT.5.6
1.NBT.5.6

1.NBT.3
1.NBT.3

1.MD.1
1.MD.1

1.G.2
1.G.2

1.G.3
1.G.3

1.G.1
1.G.1

1.MD.2
1.MD.2

1.MD.3
1.MD.3

to 15
1.OA.1

1.OA.5
1.OA.5

1.OA.3
1.OA.3

1.OA.4
1.OA.4

no fluency
1.OA.6

1.OA.6
1.OA.6

1.NBT.2
1.NBT.2

1.NBT.1
1.NBT.1

1.NBT.4
1.NBT.4

1.NBT.5.6
1.NBT.5.6

1.NBT.3
1.NBT.3

1.MD.1
1.MD.1

1.G.2
1.G.2

1.G.3
1.G.3

1.G.1
1.G.1

1.MD.2
1.MD.2

1.MD.3
1.MD.3

1.OA.1
1.OA.1

1.OA.2
1.OA.2

1.OA.8
1.OA.8

1.OA.7
1.OA.7

1.MD.4
1.MD.4

1.NBT.4
1.NBT.4

no concrete or drawings
1.NBT.4

1.OA.1
1.OA.1

1.OA.6
1.OA.6

1.NBT.4
1.NBT.4

1.NBT.5.6
1.NBT.5.6

1.NBT.3
1.NBT.3

1.MD.1
1.MD.1

1.G.2
1.G.2

1.G.3
1.G.3

1.G.1
1.G.1

1.MD.2
1.MD.2

1.MD.3
1.MD.3

1.OA.1
1.OA.1

1.OA.2
1.OA.2

1.OA.8
1.OA.8

1.OA.7
1.OA.7

1.MD.4
1.MD.4

1.NBT.4
1.NBT.4

no concrete or drawings
1.NBT.4

1.OA.1
1.OA.1

1.OA.6
1.OA.6

1.NBT.4
1.NBT.4

1.NBT.5.6
1.NBT.5.6

1.NBT.3
1.NBT.3

1.MD.1
1.MD.1

1.G.2
1.G.2

1.G.3
1.G.3

1.G.1
1.G.1

1.MD.2
1.MD.2

1.MD.3
1.MD.3

1.OA.1
1.OA.1

1.OA.2
1.OA.2

1.OA.8
1.OA.8

1.OA.7
1.OA.7

1.MD.4
1.MD.4

1.NBT.4
1.NBT.4

no concrete or drawings
1.NBT.4

1.OA.1
1.OA.1

1.OA.6
1.OA.6

1.NBT.4
1.NBT.4

1.NBT.5.6
1.NBT.5.6

1.NBT.3
1.NBT.3

1.MD.1
1.MD.1

1.G.2
1.G.2

1.G.3
1.G.3

1.G.1
1.G.1

1.MD.2
1.MD.2

1.MD.3
1.MD.3

1.OA.1
1.OA.1

1.OA.2
1.OA.2

1.OA.8
1.OA.8

1.OA.7
1.OA.7

1.MD.4
1.MD.4

1.NBT.4
1.NBT.4

no concrete or drawings
1.NBT.4

1.OA.1
1.OA.1

1.OA.6
1.OA.6

1.NBT.4
1.NBT.4

1.NBT.5.6
1.NBT.5.6

1.NBT.3
1.NBT.3

1.MD.1
1.MD.1

1.G.2
1.G.2

1.G.3
1.G.3

1.G.1
1.G.1

1.MD.2
1.MD.2

1.MD.3
1.MD.3

1.OA.1
1.OA.1

1.OA.2
1.OA.2

1.OA.8
1.OA.8

1.OA.7
1.OA.7

1.MD.4
1.MD.4

1.NBT.4
1.NBT.4

no concrete or drawings
1.NBT.4

1.OA.1
1.OA.1

1.OA.6
1.OA.6

1.NBT.4
1.NBT.4

1.NBT.5.6
1.NBT.5.6

1.NBT.3
1.NBT.3

1.MD.1
1.MD.1

1.G.2
1.G.2

1.G.3
1.G.3

1.G.1
1.G.1

1.MD.2
1.MD.2

1.MD.3
1.MD.3

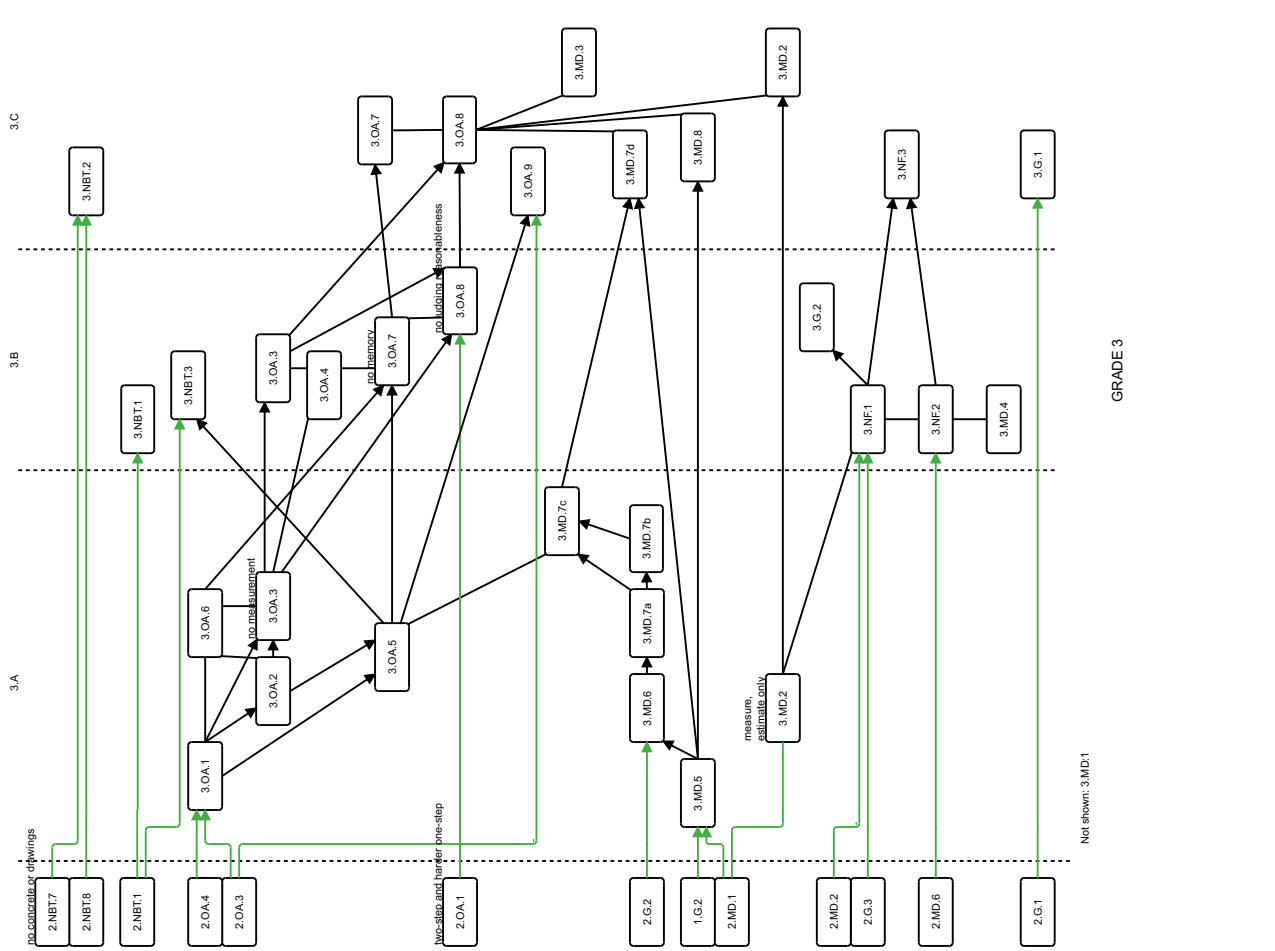
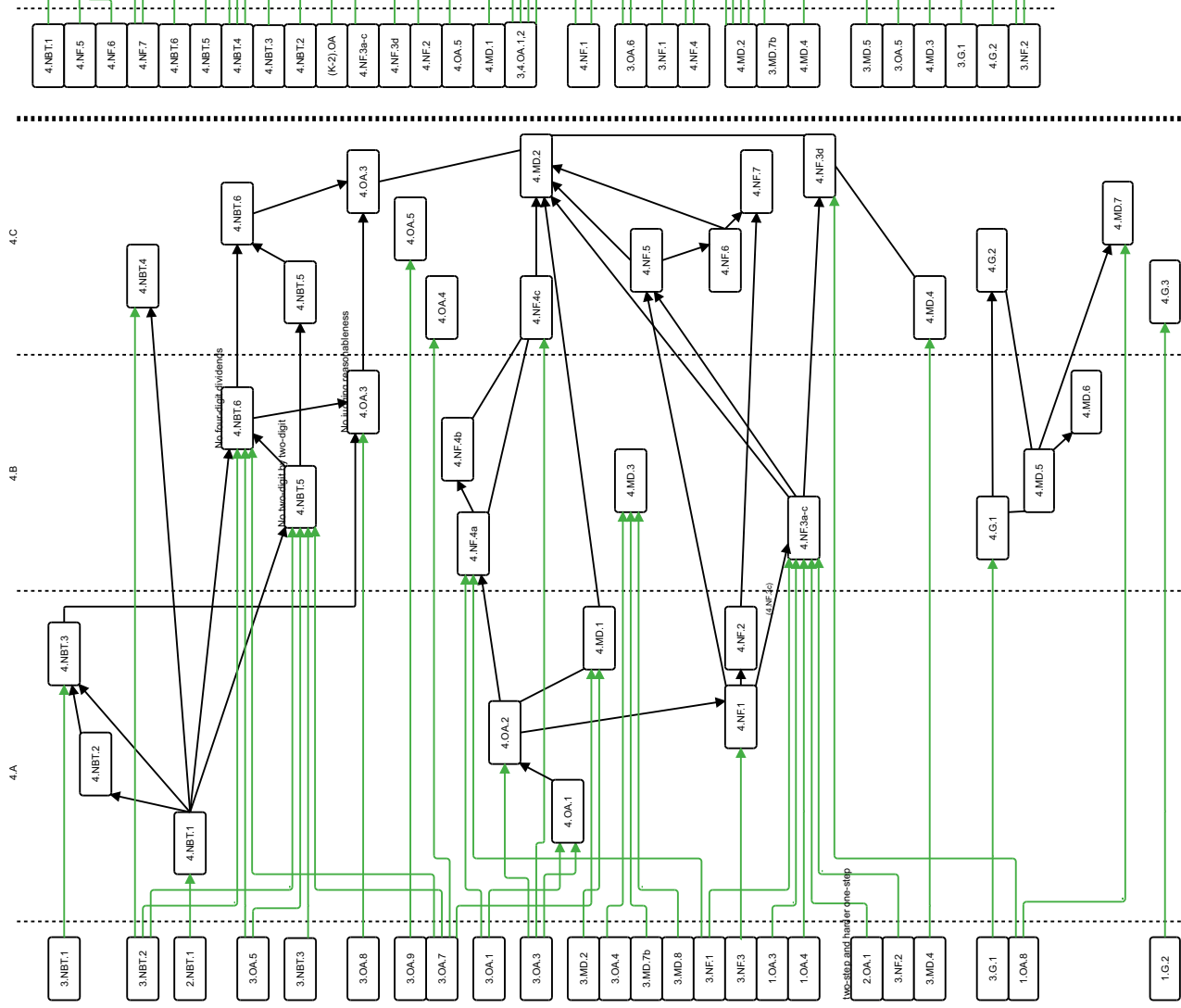

GRADE 4

GRADE 3

Not shown: 3.MD.1

6.C

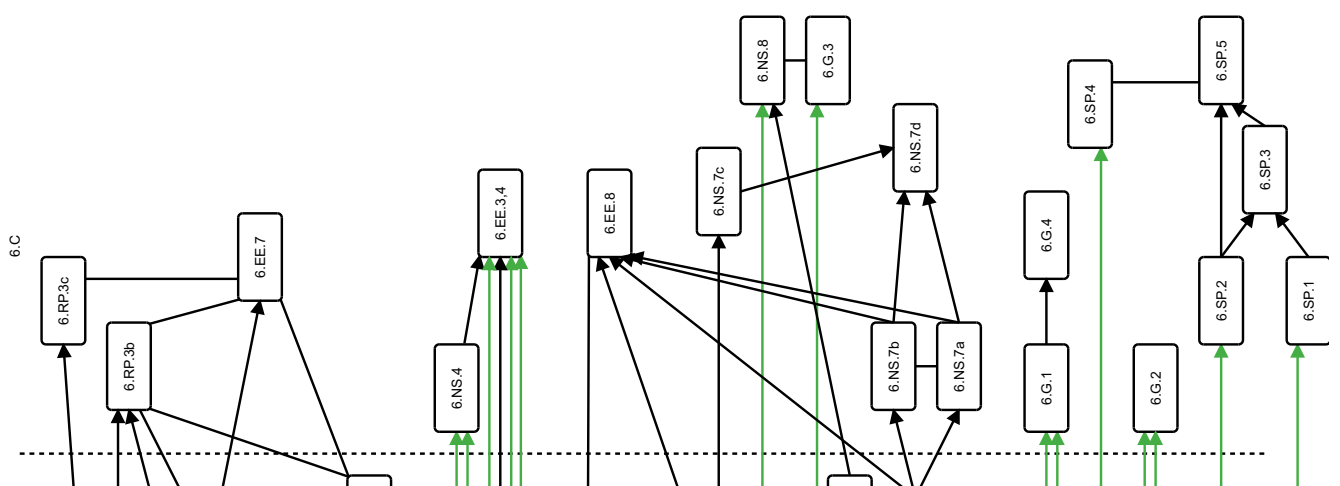

7.A

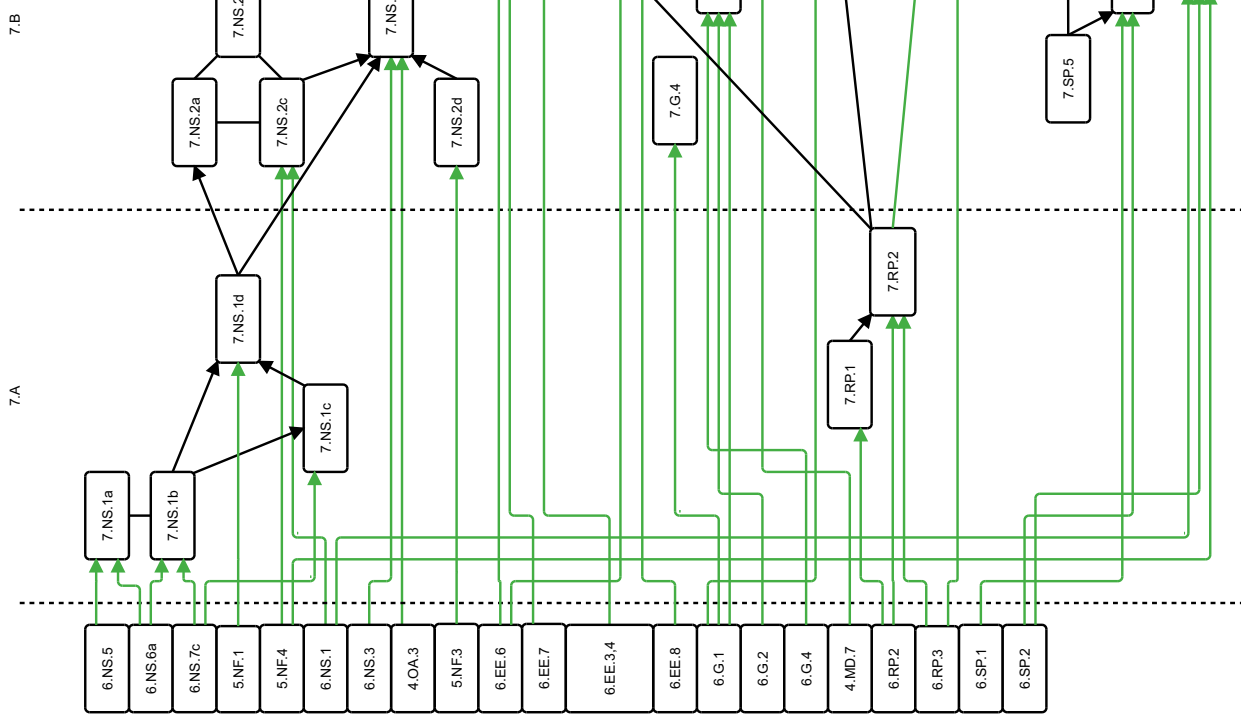

7.B

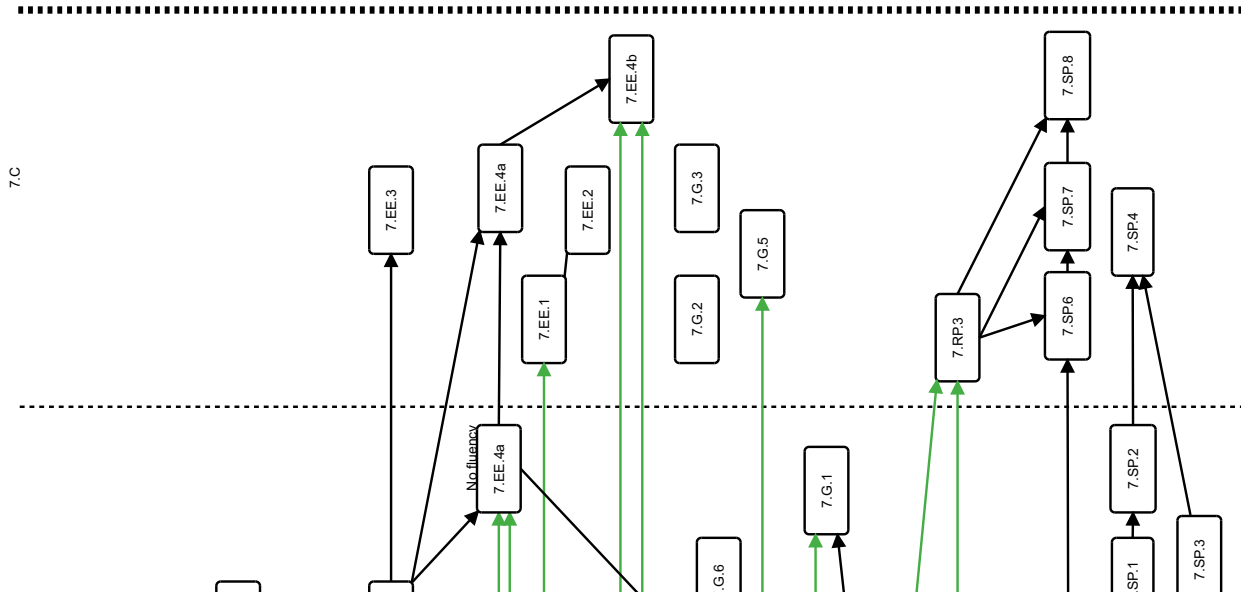

7.C

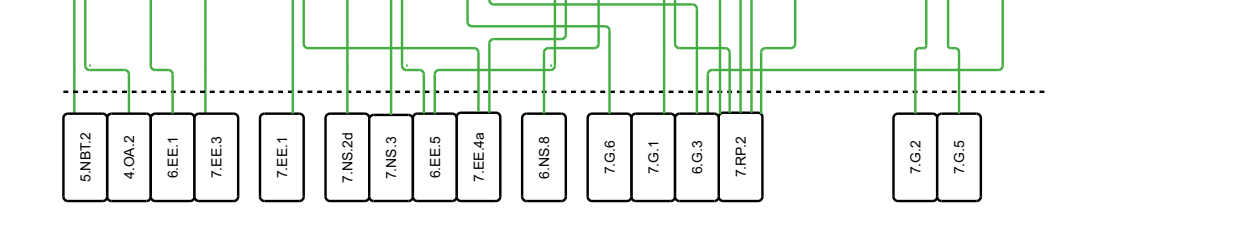

GRADE 7

7.C

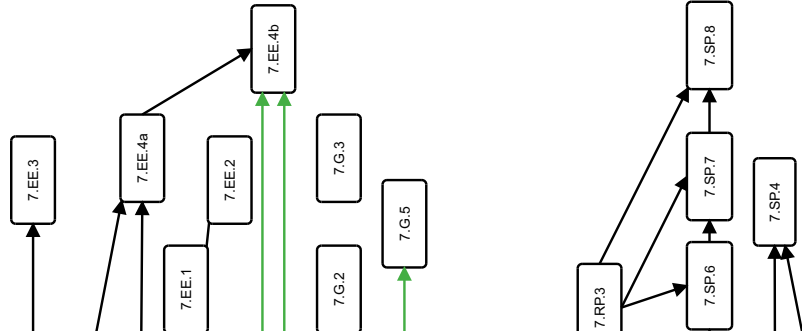

8.A

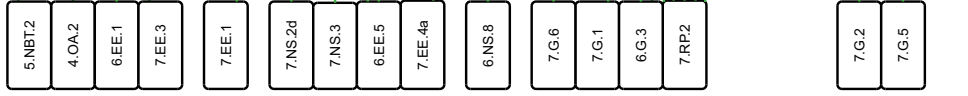

8.B

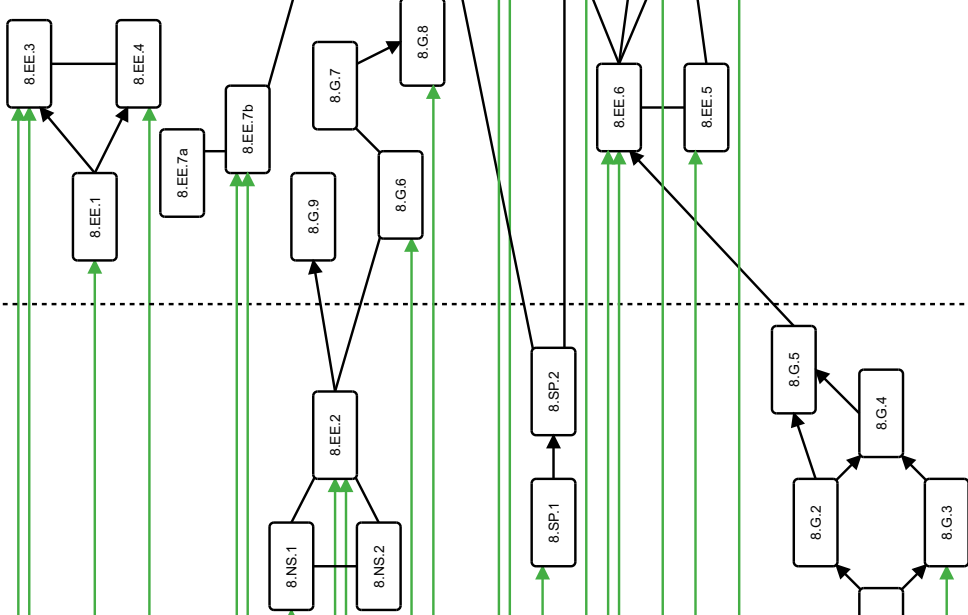

8.C

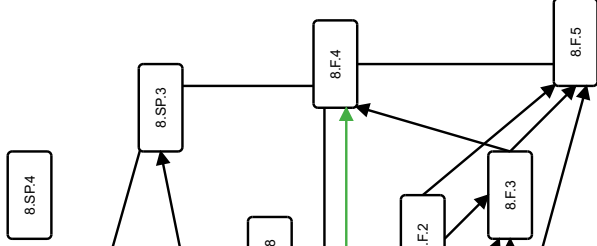

GRADE 8